

RIB04S2

Enclosed Relay 20 Amp DPST-N/O + DP Override with 480 Vac/dc Coil



Functional Devices, Inc. A600C 2005



Contact Ratings:

20 Amp Resistive @ 277 Vac
20 Amp Ballast @ 277 Vac
10 Amp Tungsten @ 120 Vac
770 VA Pilot Duty @ 120 Vac
1,110 VA Pilot Duty @ 277 Vac
2 HP @ 277 Vac
1 HP @ 120 Vac

Coil Current:

95 mA @ 480 Vac

Coil Voltage Input:

480 Vac/dc; 50-60 Hz
Drop Out = 35 Vac
Pull In = 85 Vac

Notes:

» Order Normally Closed by adding "-NC" to end of model number

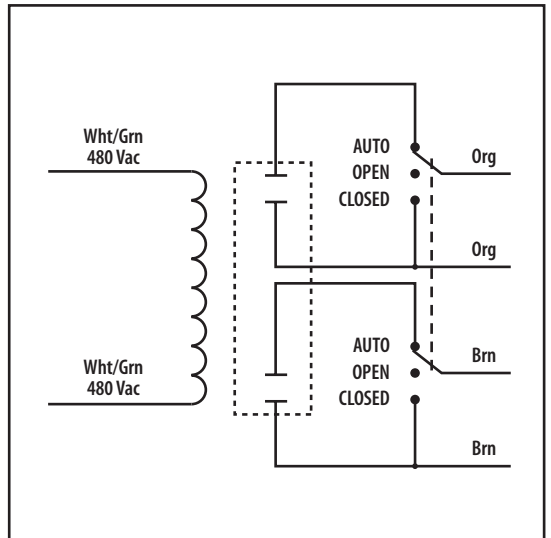

Relays & Contact Type: One (1) DPST Continuous Duty Coil
Expected Relay Life: 10 million cycles minimum mechanical
Operating Temperature: -30 to 140° F
Operate Time: 18mS
Relay Status: LED On = Activated
Dimensions: 4.00" x 4.00" x 1.80" with .50" NPT Nipple
Wires: 16', 600V Rated
Approvals: UL Listed, UL916, UL864, C-UL Canada
California State Fire Marshal, CE Approved
Housing Rating: Plenum, NEMA 1
Gold Flash: Yes
Override Switch: Yes

Notes: